

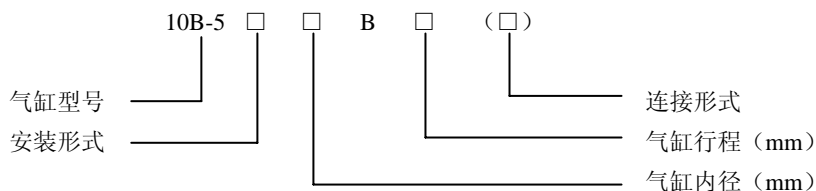

### 一、型号:



### 二、特点:

- 1、结构紧凑，外形美观。
- 2、复合 Y 型圈密封，可靠耐用。
- 3、含油轴承导向，耐磨平稳。
- 4、缸体周边顺滑流畅，方便清洁。
- 5、缓冲针阀与气口同侧，安装更方便。
- 6、无拉杆设计，缸盖紧固缸体，增强刚性。
- 7、安装尺寸与 10A-5 系列气缸相同，可相互替代。



### 三、主要技术参数:

气缸型号	10B-5 (标准型)					
气缸内径 D (mm)	Φ32	Φ40	Φ50	Φ63	Φ80	Φ100
最大行程 S (mm)	500	800			1000	
使用压力范围 (MPa)	0.05 ~ 1.0					
耐压力 (MPa)	1.5					
使用速度范围 (mm/sec)	50 ~ 700					
使用温度范围 (°C)	-25 ~ +80 (但在不冻结条件)					
使用介质	干燥洁净空气					
给油	不需要 (也可给油)					
缓冲	两侧可调缓冲					
缓冲行程 (mm)	20			25		

### 四、外形及安装尺寸

#### 1、SD (基本型)

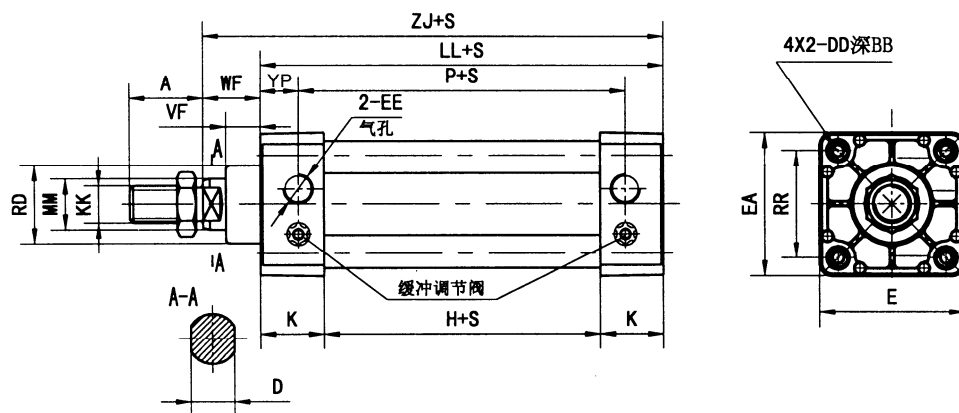



单位: mm

缸径	A	BB	D	DD	E	EA	EE	H	K	KK	LL	MM	P	RD	RR	VF	WF	YP	ZJ
Φ32	22	12	10	M6×1	44	44	G1/8	33	30	M10×1.25	93	Φ12	52	Φ28	□33	15	25	20.5	118
Φ40	24	12	13	M6×1	50	50	G1/4	35	29	M12×1.25	93	Φ16	63	Φ32	□37	15	25	15	118
Φ50	32	12	19	M6×1	62	62	G1/4	38	27.5	M16×1.5	93	Φ22	59	Φ38	□47	15	25	17	118
Φ63	32	14	19	M8×1.25	76	75	G3/8	23	36.5	M16×1.5	96	Φ22	65	Φ38	□56	15	25	15.5	121
Φ80	40	18	22	M10×1.25	94	94	G3/8	26	41	M20×1.5	108	Φ25	70	Φ47	□70	21	35	19	143
Φ100	40	18	22	M10×1.25	114	112	G1/2	29	39.5	M20×1.5	108	Φ25	70	Φ47	□84	21	35	19	143

2、LA (横向脚架式)

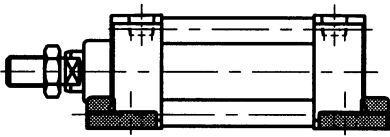

3、LB (轴向脚架式)

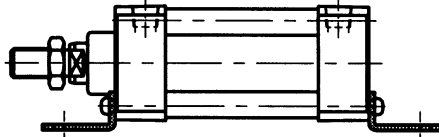

4、FA (前法兰式)

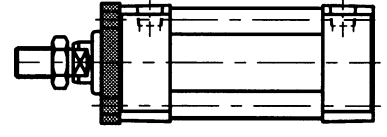

5、FB (后法兰式)

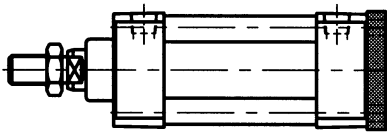

6、CA (单悬耳式)



7、CC (单悬耳式)

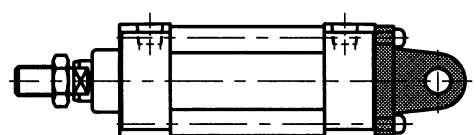

8、CB (双悬耳式)

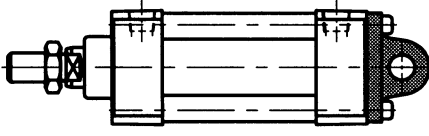

9、CBB (双悬耳座式)

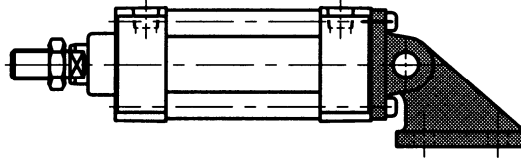

### 五、连接形式

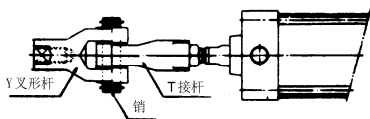

1、杆部叉式 (RT-Y)

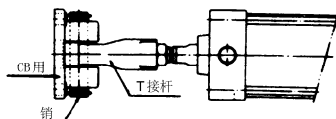

2、杆部杆座式 (RT-CB)

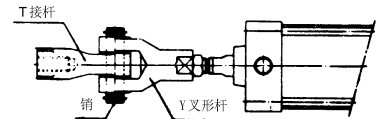

3、杆部叉杆式 (RY-T)

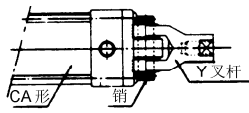

4、单悬耳叉式 (HCA-Y)

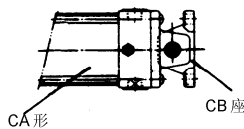

5、单悬耳座式 (HCA-CB)

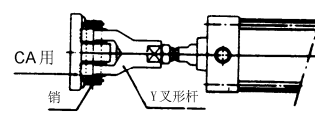

6、杆部叉座式 (RY-CA)

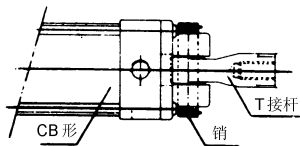

7、双悬耳杆式 (HCB-T)

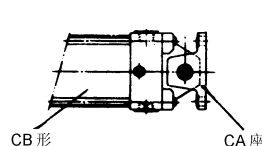

8、双悬耳座式 (HCB-CA)

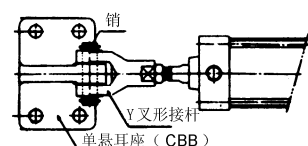

9、杆部叉座式 (RY-CBB)

有关尺寸详见气缸附件尺寸表。





### 六、附件尺寸表

单位: mm

		缸径	Φ32	Φ40	Φ50	Φ63	Φ80	Φ100	Φ125	Φ160	
LA 横向脚架 	LA	22	22	24	26	33	37	45	44		
	LB	13	14	14	14	18	18	21	22		
	LC	63	70	83	95	121	140	175	214		
	LD	80	91	104	116	146	165	211	254		
	LE	5.5	6.6	7.6	10	12	15	17	21		
	LF	8	8	9	9	12	14	17	17		
	LG	Φ9	Φ12	Φ12	Φ12	Φ14	Φ14	Φ18	Φ18		
	LH	10	10	10	10	13	13	17	18		
	LB 横向脚架 	LA	9.5	12.5	12	13	16	16	18	20	
		LB	20.5	23.5	28	31	30	30	35	40	
LC		33	36	47	56	70	84	104	134		
LD		50	57	68	80	97	112	136	170		
LE		11.5	11.5	13.1	13	14	15	18	24		
LF		3	3	3	3	4	4	6	8		
LG		Φ9	Φ12	Φ12	Φ12	Φ14	Φ14	Φ18	Φ17		
FA 前法兰 FB 后法兰 		FA	10	10	10	12	16	16	20	25	
		FB	33	36	47	56	70	84	104	134	
		FC	47	52	65	76	95	115	138	172	
	FD	58	70	86	98	119	138	168	208		
	FE	72	84	104	116	143	162	196	240		
	FF	Φ7	Φ7	Φ9	Φ9	Φ12	Φ12	Φ14	Φ17		
	CA 单悬耳 CC 单悬耳 	CA	8	8	10	13	18	18	18	20	
		Ca	10	10	10	10	14	14	14	15	
		CB	19	19	19	19	32	32	32	40	
		Cb	34	34	34	34	48	48	48	55	
CC		31	33	33	33	52	52	52	70		
Cc		46	48	49	49	68	68	68	83		
CD		Φ12	Φ14	Φ14	Φ14	Φ20	Φ20	Φ20	Φ28		
CE		16	20	20	20	32	32	32	40		
CB 双悬耳 		CA	8	8	8	8	11	11	14	15	
		CB	19	19	19	19	32	32	32	40	
	CC	32	32	34	34	53	53	53	68		
	CD	Φ12	Φ14	Φ14	Φ14	Φ20	Φ20	Φ20	Φ28		
	CE	16	20	20	20	32	32	32	40		
	CF	32	44	52	52	64	64	64	80		



缸径	Φ32	Φ40	Φ50	Φ63	Φ80	Φ100	Φ125	Φ160
BA	40	40	40	40	65	65	77	120
BB	60	70	70	70	95	95	112	165
BC	8	8	8	8	12	12	15	23
BD	55	65	65	65	85	85	112	142.5
BE	65	80	80	80	105	105	110	130
BF	85	105	105	105	135	135	145	175
BG	35	45	45	45	60	60	75	115
BH	Φ9	Φ11	Φ11	Φ11	Φ14	Φ14	Φ18	Φ22
BI	Φ12	Φ14	Φ14	Φ14	Φ20	Φ20	Φ20	Φ28
A	23	25	33	33	41	41	56	69
CA	55	60	60	60	85	85	100	125
CD	Φ12	Φ14	Φ14	Φ14	Φ20	Φ20	Φ20	Φ28
ER	R12	R12	R14	R14	R19	R19	R20	28
EW	16	20	20	20	32	32	32	40
KK	M10× 1.25	M12× 1.25	M16× 1.5	M16× 1.5	M20× 1.5	M20× 1.5	M27× 2	M36× 2
CC	20	20	18	18	28	28	35	36.5
CB	20	20	20	20	30	30	32	33
CP	46	58	58	58	78	78	78	97
CT	32	44	44	44	64	64	64	80
ED	Φ36	Φ40	Φ42	Φ42	Φ50	Φ50	Φ56	Φ60
TA	18	20	24	24	30	30	41	62
SA	43	50	64	64	77	77	103	115
FA	29	29	36	36	47	56	68	71
FB	21	21	28	28	34	34	47	50
FE	14	14	16	16	22	24	36	42
FJ	70	70	89	89	110	123	157	171
FM	Φ34	Φ34	Φ44	Φ44	Φ52	Φ52	Φ64	Φ70
SW	16	20	21	21	25	25	35	40

