

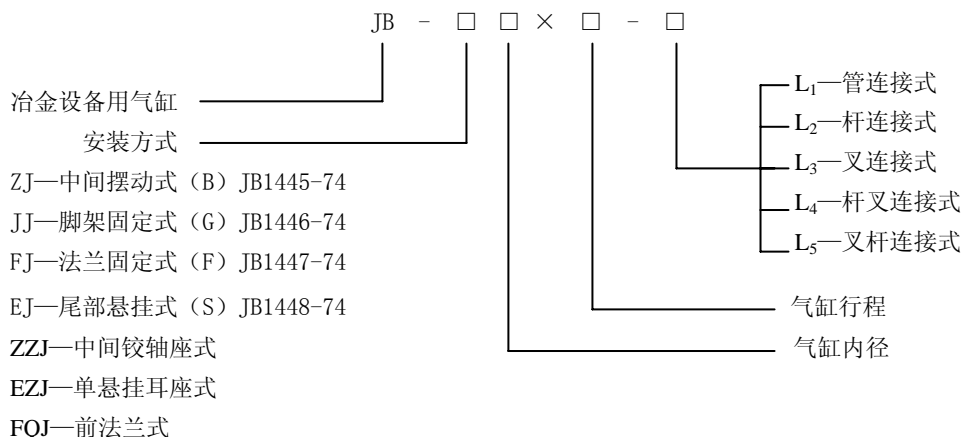

一、型号



二、特点

- 1、符合 JB1444~1448-74 标准，目前冶金行业广泛应用。
- 2、品种规格齐全，安装附件和连接附件种类多，适应用户不同需要。

三、主要技术参数

气缸缸径 (mm)	80	100	125	160	180	200	250	320	400
最大行程 (mm)	600		800		1000		1250	1600	
工作介质	经过净化并有油雾的压缩空气								
使用温度范围 (°C)	- 25 ~ + 80 (但在不冻结条件下)								
工作压力范围 (MPa)	0.15~0.8								
使用速度范围 (mm/s)	100~500								

四、图形符号及外形尺寸

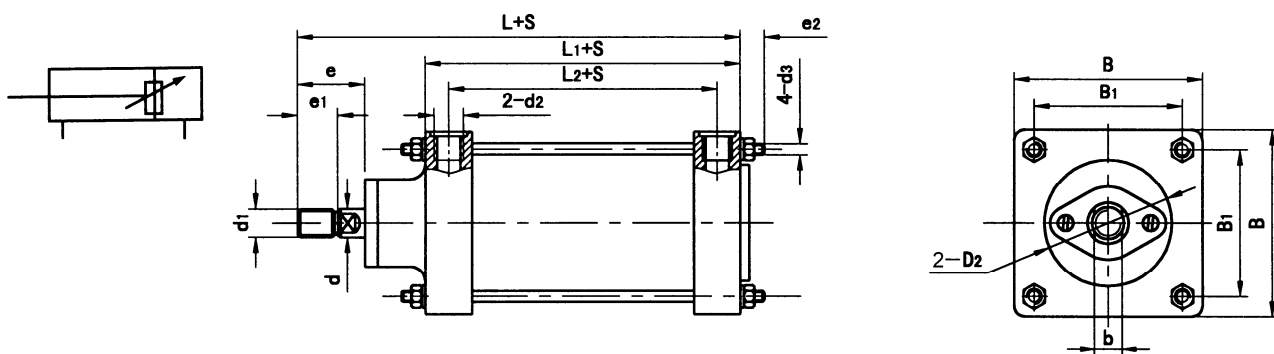

单位: mm

型号	D ₂	L	L ₁	L ₂	d	d ₁	d ₂	d ₃	e	e ₁	e ₂	B	B ₁	b
JB80×S	95	240	135	105	30	M20×1.5	M14×1.5	M12	50.5	35	30	115	85	24
JB100×S	95	240	135	105	30	M20×1.5	M14×1.5	M12	50.5	35	30	130	100	24
JB125×S	130	310	180	140	40	M24×2	M18×1.5	M16	59	40	40	160	120	36
JB160×S	130	310	180	140	40	M24×2	M18×1.5	M16	59	40	40	190	150	36
JB180×S	170	350	190	150	50	M30×2	M18×1.5	M20	84	50	40	220	170	41
JB200×S	170	350	190	150	50	M30×2	M18×1.5	M20	84	50	40	240	190	41
JB250×S	200	450	240	180	70	M42×3	M27×2	M24	109	60	50	290	230	65
JB320×S	240	520	260	200	90	M56×4	M33×2	M30	118	70	60	350	280	75
JB400×S	240	520	260	200	90	M56×4	M33×2	M36	118	70	60	430	350	75

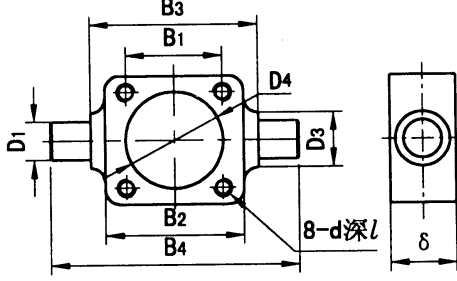
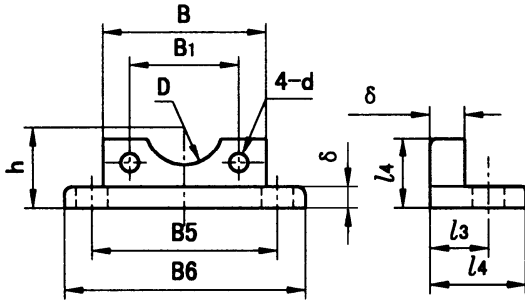
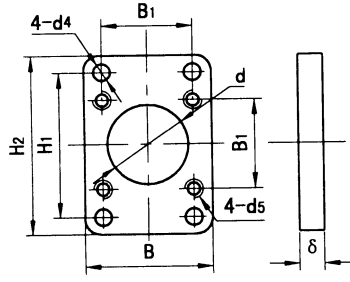
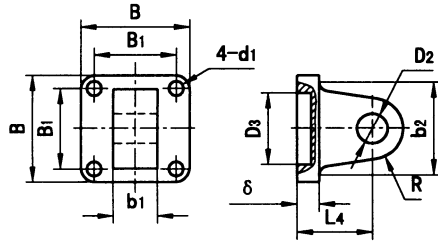

五、安装及连接附件尺寸

配用 JB 气缸安装与连接附件		缸径	80	100	125	160	180	200	250	320	400		
B-摆轴型式与尺寸 (或 ZJ-铰轴) 		B ₁	85	100	120	150	170	190	230	280	350		
		B ₂	115	140	170	210	230	250	310	400	490		
		B ₃	150	175	210	240	270	300	360	420	530		
		B ₄	210	235	290	320	370	400	500	600	710		
		D ₁	30	30	40	40	50	50	70	90	90		
		D ₂	45	45	55	55	65	65	85	105	105		
		D ₃	89	108	140	180	194	219	273	351	426		
		d	M12	M12	M16	M16	M20	M20	M24	M30	M36		
		l	16	16	20	20	25	25	30	37	37		
		delta	50	50	60	60	70	70	100	130	130		
		G-脚架型式与尺寸 (或 JJ-脚架) 		B	115	130	160	190	220	240	290	350	430
				B ₁	85	100	120	150	170	190	230	280	350
				B ₅	145	150	190	210	230	260	320	350	390
				B ₆	180	185	230	250	280	310	390	420	470
d	13			13	17	17	22	22	26	33	39		
delta	8			8	10	10	14	14	16	20	20		
D	95			95	130	130	170	170	200	240	240		
l ₃	45.5			45.5	60	60	69	69	103.5	115	115		
l ₄	75			75	100	100	125	125	160	200	200		
h	85			95	115	130	150	160	195	250	285		
F-法兰型式与尺寸 (或 FJ-法兰) 				B	115	130	160	190	220	240	290	350	430
				B ₁	85	100	120	150	170	190	230	280	350
				d	95	95	130	130	170	170	200	240	240
				d ₁	13	13	17	17	22	22	26	33	39
		d ₅	M12	M12	M16	M16	M20	M20	M24	M30	M36		
		H ₁	145	160	200	230	260	280	340	420	490		
		H ₂	180	200	240	270	320	340	410	500	570		
		delta	16	16	20	20	25	25	30	40	40		
		S-尾部悬挂型式与尺寸 (或 EJ-单悬耳) 		B	115	130	160	190	220	240	290	350	430
				B ₁	85	100	120	150	170	190	230	280	350
				b ₁	30	30	40	40	50	50	60	80	80
				b ₂	70	70	90	90	120	120	160	190	190
				D ₂	25	25	30	30	35	35	40	50	50
				D ₃	95	95	130	130	170	170	200	240	240
L ₄	50			50	60	60	75	75	85	110	110		
delta	16			16	20	20	25	25	30	40	40		
R	25			25	30	30	35	35	40	50	50		
d ₁	13			13	17	17	22	22	26	33	39		

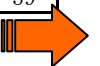

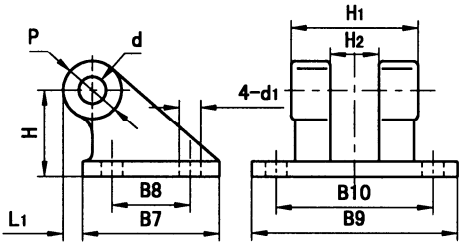
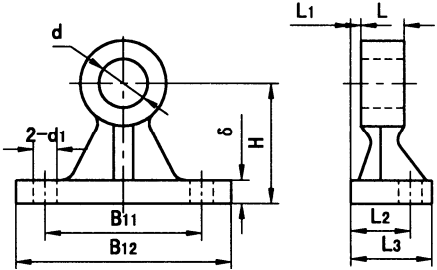
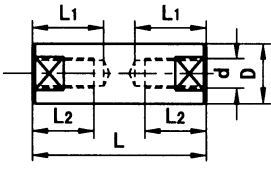
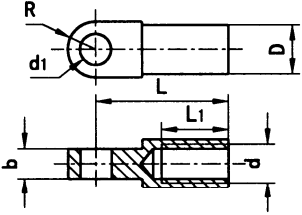
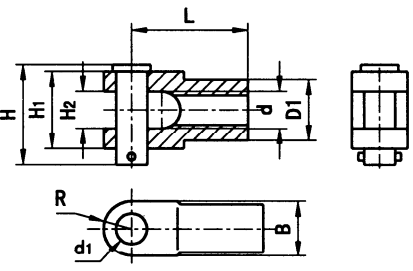

配件 JB 气缸安装与连接附件		缸径	Φ80	Φ100	Φ125	Φ160	Φ180	Φ200	Φ250	Φ320	Φ400		
SZJ-尾部悬挂座型式与尺寸 (或 EZJ-单悬耳座式) 		B ₉	115	115	160	160	220	220	290	350	430		
		B ₁₀	85	85	120	120	170	170	230	280	350		
		B ₇	90	90	110	110	150	150	190	240	300		
		B ₈	60	60	70	70	100	100	140	170	220		
		d	25	25	30	30	35	35	40	50	50		
		d ₁	13	13	17	17	22	22	26	33	39		
		D	50	50	60	60	70	70	80	100	100		
		H	85	85	120	120	150	150	195	250	270		
		H ₁	60	60	80	80	100	100	120	160	160		
		H ₂	30	30	40	40	50	50	60	80	80		
		L ₁	5	5	10	10	15	15	20	20	20		
		BZJ-摆动座型式与尺寸 (或 ZZJ-铰轴支座) 		B ₁₁	50	50	70	70	90	90	105	130	130
				B ₁₂	80	80	110	110	140	140	175	220	220
d	30			30	40	40	50	50	70	90	90		
d ₁	13			13	17	17	22	22	26	33	39		
H	85			85	120	120	150	150	195	250	250		
δ	16			16	20	20	25	25	30	40	40		
L	30			30	40	40	50	50	70	90	90		
L ₁	3			3	4	4	4	4	5	5	5		
L ₂	30			30	40	40	55	55	65	90	90		
L ₃	45			45	60	60	80	80	100	135	135		
L ₁ -管连接件 		L	80	80	90	90	100	100	130	160	160		
		L ₁	35	35	40	40	45	45	62	75	75		
		L ₂	30	30	35	35	40	40	55	65	65		
		d	M20×1.5	M20×1.5	M24×2	M24×2	M30×2	M30×2	M42×3	M56×4	M56×4		
		D	30	30	35	35	45	45	63	80	80		
L ₂ -杆连接件 		d	M20×1.5	M20×1.5	M24×2	M24×2	M30×2	M30×2	M42×3	M56×4	M56×4		
		d ₁	20	20	25	25	30	30	40	50	50		
		b	20	20	25	25	30	30	45	60	60		
		L	90	90	100	100	110	110	130	150	150		
		D	40	40	45	45	55	55	75	90	90		
		L ₁	30	30	35	35	45	45	50	60	60		
		R	25	25	30	30	35	35	45	55	55		
L ₃ -叉连接件 		d	M20×1.5	M20×1.5	M24×2	M24×2	M30×2	M30×2	M42×3	M56×4	M56×4		
		d ₁	20	20	25	25	30	30	40	50	50		
		L	65	65	75	75	90	90	110	135	135		
		H	54	54	65	65	75	75	101	137	137		
		H ₁	40	40	50	50	58	58	80	110	110		
		H ₂	20	20	25	25	30	30	45	60	60		
		B	50	50	60	60	70	70	90	110	110		
		D ₁	32	32	40	40	50	50	75	90	90		
		R	25	25	30	30	35	35	45	55	55		