

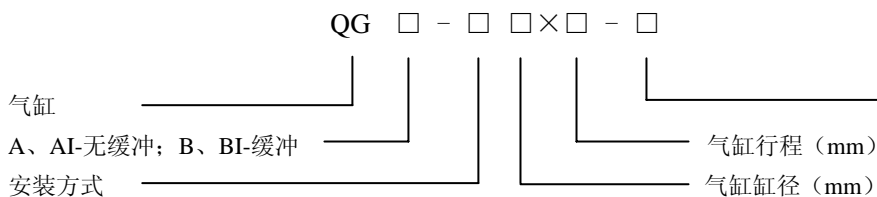

方大气动

QGA、QGB 系列气缸

一、型号



连接件:
 L₁—管式连接件
 L₂—杆式连接件
 L₃—叉连接件
 L₄—杆叉连接件
 L₅—叉杆连接件

- | | | | |
|-----|--------|-----|--------|
| E | —单悬耳式 | FQ | —前法兰式 |
| EZ | —单悬耳座式 | Z | —铰轴式 |
| ES | —双悬耳式 | ZZ | —铰轴座式 |
| ESZ | —双悬耳座式 | J | —脚架式 |
| F | —后法兰式 | 无字母 | —不带安装件 |

二、图形符号及外观

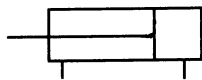

无缓冲气缸

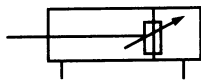

缓冲气缸



三、特点

- 1、本公司传统产品，生产历史长。经不断改进，可靠耐用。
- 2、缸径范围大，Φ32~Φ400，行程在最大范围内任选，还可商议订购加长行程气缸。
- 3、缸径Φ32~Φ100 缸的前后端盖材料为铝合金，缸筒为内孔经硬质阳极氧化处理的精密铝管。缸径Φ125~Φ400 缸的前后端盖材料为铸铁，缸筒为内孔镀铬的精密无缝钢管。
- 4、安装附件和连接件种类多，满足各种用途。

四、主要技术参数

型 号	QGA					QGB					QGAI	QGBI
缸径 (mm)	32	40	50	63	80	100	125	160	200	400	250	320
最大行程 (mm)	500	800			1000			2000				
工作压力 (MPa)	0.15~0.8											
耐压力 (MPa)	1.2											
使用温度范围 (°C)	-25~+80 (但在不冻结条件下)											
工作介质	经过净化并含有油雾的压缩空气											

五、外形及安装尺寸

1、基本型气缸

QGA、QGAI 系列

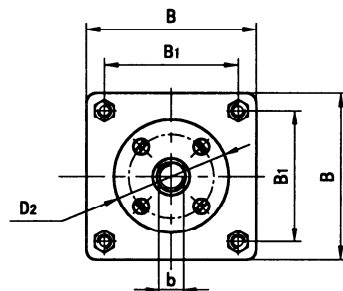
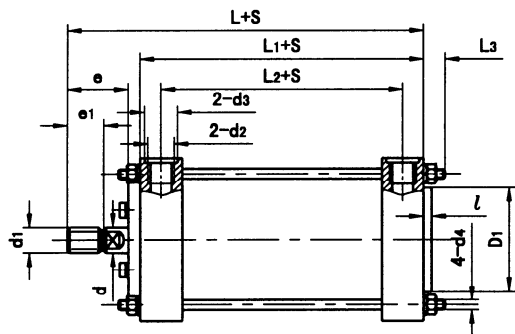



QGB、QGBI 系列

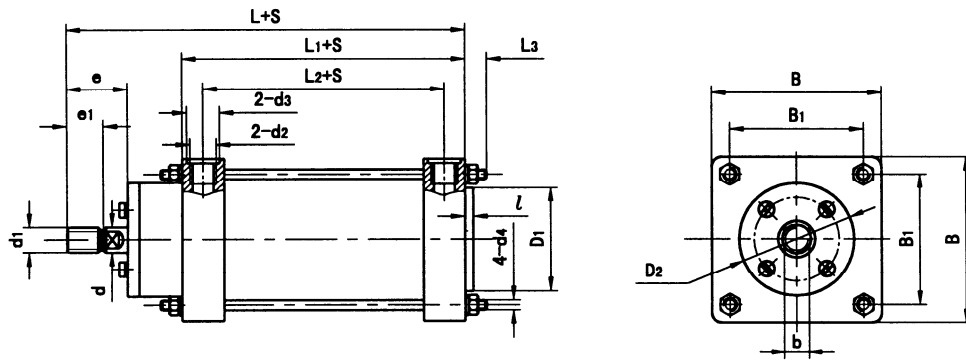

单位: mm

型号	d	d ₁	d ₂	d ₃	d ₄	L	L ₁	L ₂	L ₃	e	e ₁	B	B ₁	b	l	D ₁	D ₂
QGA 32×S	10	M10	M10×1	13	M5	122	73	53	8	33	15	45	35	8	/	/	Φ24
QGB 32×S	10	M10	M10×1	13	M5	122	73	53	8	31	15	45	35	8	/	/	Φ24
QGA 40×S	16	M12×1.25	M10×1	13	M6	150	95	75	8	38	25	55	40	14	5	Φ30	Φ30
QGB 40×S	16	M12×1.25	M10×1	13	M6	177	115	85	8	40	25	55	40	14	5	Φ30	Φ30
QGA 50×S	16	M12×1.25	M10×1	13	M6	150	95	75	8	38	25	64	50	14	5	Φ30	Φ30
QGB 50×S	16	M12×1.25	M10×1	13	M6	177	115	85	8	40	25	64	50	14	5	Φ30	Φ30
QGA 63×S	20	M16×1.5	M12×1.25	16	M8	190	130	105	8	45	30	80	60	17	5	Φ39	Φ39
QGB 63×S	20	M16×1.5	M12×1.25	16	M8	205	135	105	8	45	30	80	60	17	5	Φ39	Φ39
QGA 80×S	20	M16×1.5	M16×1.5	20	M8	190	130	102	8	45	30	95	75	17	5	Φ39	Φ39
QGB 80×S	20	M16×1.5	M16×1.5	20	M8	205	135	104.5	8	45	30	95	75	17	5	Φ39	Φ39
QGA 100×S	25	M20×1.5	M16×1.5	20	M10	203	135	107	22.5	58	35	115	90	22	5	Φ52	Φ40
QGB 100×S	25	M20×1.5	M16×1.5	20	M10	243	145	112	22.5	58	35	115	90	22	5	Φ52	Φ45
QGA 125×S	32	M27×2	M20×1.5	24	M12	220	145	107	27.5	65	40	150	120	27	6	Φ90	Φ68
QGB 125×S	32	M27×2	M20×1.5	24	M12	250	145	107	27.5	65	40	150	120	27	6	Φ90	Φ90
QGA 160×S	40	M33×2	M27×2	32	M16	275	190	150	37.5	75	50	190	150	36	8	Φ100	Φ78
QGB 160×S	40	M33×2	M27×2	32	M16	310	190	150	37.5	67	50	190	150	36	8	Φ100	Φ100
QGA 200×S	40	M36	M27×2	32	M20	285	200	150	37.5	75	60	230	180	36	/	/	Φ78
QGB 200×S	40	M36	M27×2	32	M20	323	200	150	37.5	75	60	230	180	36	/	/	Φ100
QGA1250×S	63	M42×2	M33×2	35.4	M24	386	194	140	50	154	84	280	230	55	/	/	Φ126
QGB1250×S	63	M42×2	M33×2	35.4	M24	386	194	140	50	154	84	280	230	55	/	/	Φ126
QGA1320×S	80	M48×2	M33×2	35.4	M30	430	208	154	60	176	96	350	290	75	/	/	Φ144
QGB1320×S	80	M48×2	M33×2	35.4	M30	430	208	154	60	176	96	350	290	75	/	/	Φ144
QGA 400×S	90	M56×4	M42×2	46	M36	434	260	195	60	120	70	430	350	80	/	/	Φ180
QGB 400×S	90	M56×4	M42×2	46	M36	434	260	195	60	120	70	430	350	80	/	/	Φ180

2、带安装附件气缸

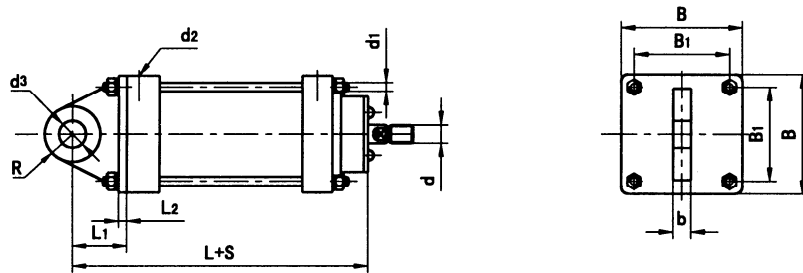

单悬耳式气缸 (E 型)

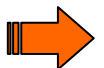

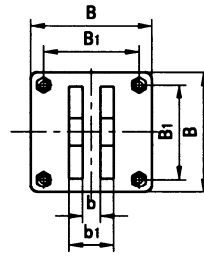
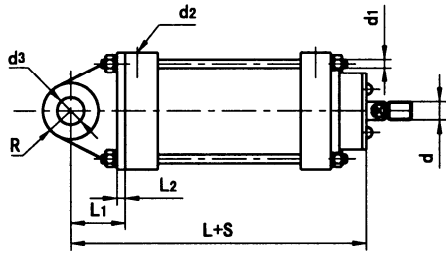

双悬耳式气缸 (ES 型)

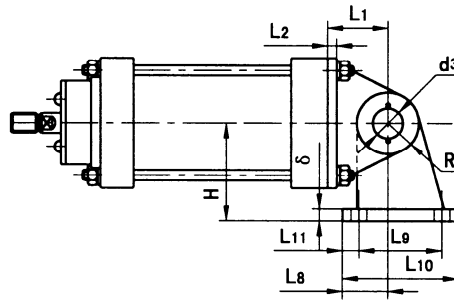
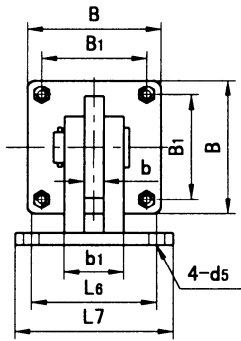

单悬耳座式气缸 (EZ 型)

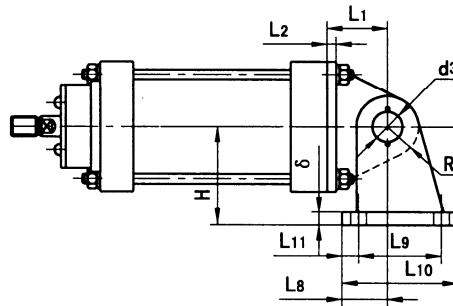
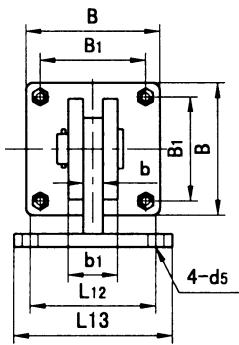

双悬耳座式气缸 (ESZ 型)

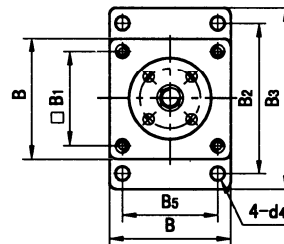
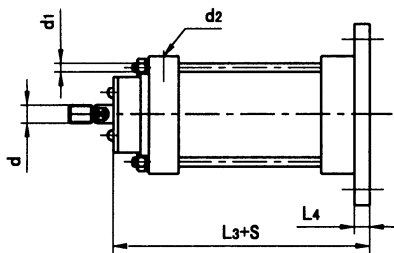

后法兰式气缸 (F 型)

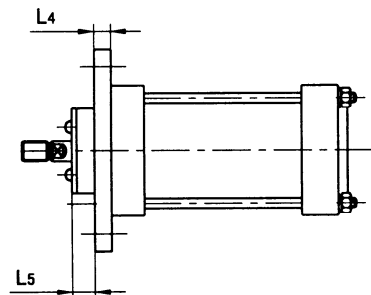
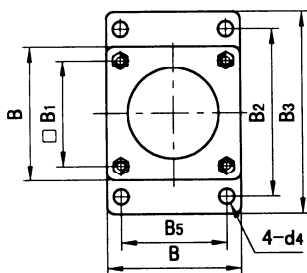

前法兰式气缸 (FQ 型)

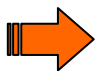



型号	d	d ₁	d ₂	d ₃	d ₄	d ₅	L	L ₁	L ₂	L ₃	L ₄	L ₅	L ₆
QGA 32	M10	M5	M10×1	10	6	6	129	40	8	97	8	8	35
QGB 32	M10	M5	M10×1	10	6	6	131	40	8	99	8	10	35
QGA 40	M12×1.25	M6	M10×1	15	7	9	157	45	10	124	12	5	65
QGB 40	M12×1.25	M6	M10×1	15	7	9	182	45	10	149	12	10	65
QGA 50	M12×1.25	M6	M10×1	15	7	9	157	45	10	124	12	5	65
QGB 50	M12×1.25	M6	M10×1	15	7	9	182	45	10	149	12	10	65
QGA 63	M16×1.5	M8	M12×1.25	20	9	9	205	60	12	159	14	1	74
QGB 63	M16×1.5	M8	M12×1.25	20	9	9	220	60	12	174	14	11	74
QGA 80	M16×1.5	M8	M16×1.5	20	9	9	205	60	12	159	14	1	74
QGB 80	M16×1.5	M8	M16×1.5	20	9	9	220	60	12	174	14	11	74
QGA 100	M20×1.5	M10	M16×1.5	25	11	11	225	80	15	161	16		95
QGB 100	M20×1.5	M10	M16×1.5	25	11	11	265	80	15	201	16	24	95
QGA 125	M27×2	M12	M20×1.5	25	13	11	255	100	20	171	16		95
QGB 125	M27×2	M12	M20×1.5	25	13	11	285	100	20	201	16	24	95
QGA 160	M33×2	M16	M27×2	30	17	17	320	120	20	220	20		120
QGB 160	M33×2	M16	M27×2	30	17	17	353	120	20	253	20	33	120
QGA 200	M36	M20	M27×2	35	22	22	285	75	25	235	25		180
QGB 200	M36	M20	M27×2	35	22	22	323	75	25	273	25	23	180
QGA 250	M42×2	M24	M33×2	40	26	26	305	73	28	260	28	10	230
QGB 250	M42×2	M24	M33×2	40	26	26	305	73	28	260	28	10	230
QGA 320	M48×2	M30	M33×2	45	33	32	340	86	36	290	36	10	290
QGB 320	M48×2	M30	M33×2	45	33	32	340	86	36	290	36	10	290
QGA 400	M56×4	M36	M42×2	60	39	39	424	110	40	354	40	14	350
QGB 400	M56×4	M36	M42×2	60	39	39	424	110	40	354	40	14	350

型号	L ₇	L ₈	L ₉	L ₁₀	L ₁₁	L ₁₂	L ₁₃	δ	B	B ₁	B ₂	B ₃	B ₄	b	b ₁	H	R
QGA 32	45	22.5	35	45	5	35	45	8	45	35	70	80	35	12	24	40	10
QGB 32	45	22.5	35	45	5	35	45	8	45	35	70	80	35	12	24	40	10
QGA 40	85	15	25	40	7	40	60	10	55	40	70	85	40	12	32	45	15
QGB 40	85	15	25	40	7	40	60	10	55	40	70	85	40	12	32	45	15
QGA 50	85	15	25	40	7	40	60	10	64	50	78	92	50	12	36	45	15
QGB 50	85	15	25	40	7	40	60	10	64	50	78	92	50	12	36	45	15
QGA 63	100	20	35	65	12	54	80	13	80	60	100	120	60	20	42	60	20
QGB 63	100	20	35	65	12	54	80	13	80	60	100	120	60	20	42	60	20
QGA 80	100	20	35	65	12	54	80	13	95	75	115	135	75	20	42	60	20
QGB 80	100	20	35	65	12	54	80	13	95	75	115	135	75	20	42	60	20
QGA 100	125	25	56	80	12	70	100	16	115	90	140	165	90	25	54	80	25
QGB 100	125	25	56	80	12	70	100	16	115	90	140	165	90	25	54	80	25
QGA 125	125	25	56	80	12	70	100	16	150	120	180	215	120	25	56	80	25
QGB 125	125	25	56	80	12	70	100	16	150	120	180	215	120	25	56	80	25
QGA 160	160	30	60	100	20	80	120	21	190	150	230	270	150	30	72	110	30
QGB 160	160	30	60	100	20	80	120	21	190	150	230	270	150	30	72	110	30
QGA 200	230	35	180	230	25	180	230	25	230	180	270	320	180	50	100	160	35
QGB 200	230	35	180	230	25	180	230	25	230	180	270	320	180	50	100	160	35
QGA 250	280	40	140	190	25	230	280	28	280	230	330	395	165	110	200	190	40
QGB 250	280	40	140	190	25	230	280	28	280	230	330	395	165	110	200	190	40
QGA 320	350	45	160	230	35	290	350	36	350	290	400	475	200	120	220	230	45
QGB 320	350	45	160	230	35	290	350	36	350	290	400	475	200	120	220	230	45
QGA 400	430	60	180	260	40	350	430	40	430	350	500	570	350	120	220	270	60
QGB 400	430	60	180	260	40	350	430	40	430	350	500	570	350	120	220	270	60

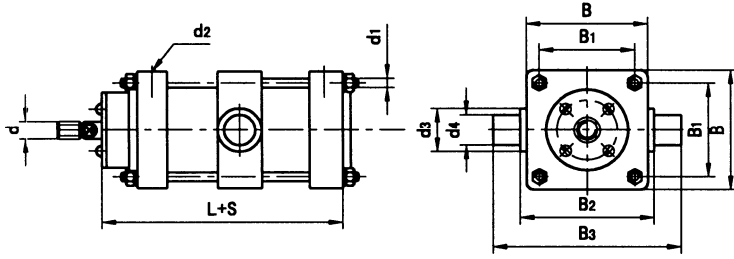

中间铰轴式气缸 (Z 型)

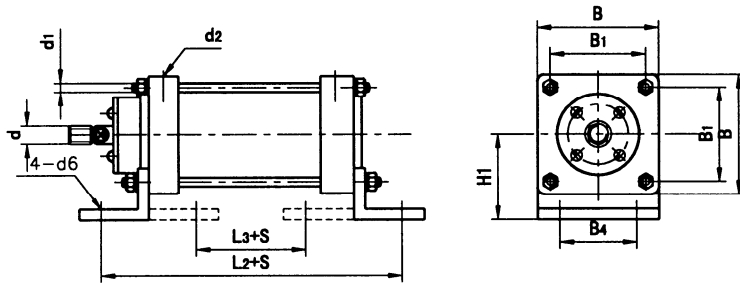

脚架式气缸 (J 型)

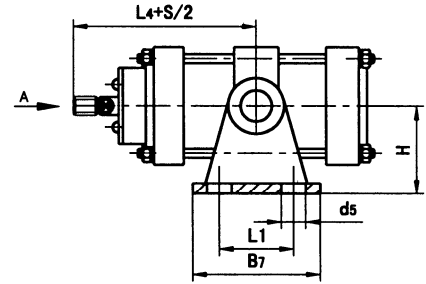

A 向

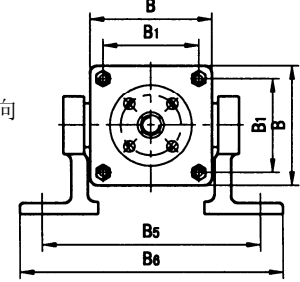

中间铰轴支座式气缸 (ZZ 型)

单位: mm

型号	d	d ₁	d ₂	d ₃	d ₄	d ₅	d ₆	L	L ₁	L ₂	L ₃	L ₄	B	B ₁	B ₂	B ₃	B ₄	B ₅	B ₆	B ₇	H	H ₁
QGA 32	M10	M5	M10×1	30	15	6	6	89	34	118	36	85.5	45	35	60	90	35	106	126	50	40	40
QGB 32	M10	M5	M10×1	30	15	6	6	91	34	118	36	85.5	45	35	60	90	35	106	126	50	40	40
QGA 40	M12×1.25	M6	M10×1	25	15	7	7	112	34	155	43	102.5	55	40	63	93	36	107	127	50	45	40
QGB 40	M12×1.25	M6	M10×1	25	15	7	7	137	34	175	63	119.5	55	40	63	93	36	107	127	50	45	40
QGA 50	M12×1.25	M6	M10×1	25	15	7	7	112	34	155	43	102.5	64	50	72	102	50	116	136	50	45	45
QGB 50	M12×1.25	M6	M10×1	25	15	7	7	137	34	175	63	119.5	64	50	72	102	50	116	136	50	45	45
QGA 63	M16×1.5	M8	M12×1.25	35	20	9	9	145	35	210	62	125	80	60	85	135	60	129	155	60	60	55
QGB 63	M16×1.5	M8	M12×1.25	35	20	9	9	160	35	215	67	137.5	80	60	85	135	60	129	155	60	60	55
QGA 80	M16×1.5	M8	M16×1.5	35	20	9	9	145	35	210	62	125	95	75	105	155	75	149	175	60	60	65
QGB 80	M16×1.5	M8	M16×1.5	35	20	9	9	160	35	215	67	137.5	95	75	105	155	75	149	175	60	60	65
QGA 100	M20×1.5	M10	M16×1.5	50	25	11	11	145	44	225	61	125.5	115	90	135	195	90	189	215	80	80	75
QGB 100	M20×1.5	M10	M16×1.5	50	25	11	11	185	44	235	71	170.5	115	90	135	195	90	189	215	80	80	75
QGA 125	M27×2	M12	M20×1.5	60	25	11	13	155	44	245	61	147.5	150	120	169	229	120	223	249	80	80	96
QGB 125	M27×2	M12	M20×1.5	60	25	11	13	185	44	245	61	177.5	150	120	169	229	120	223	249	80	80	96
QGA 160	M33×2	M16	M27×2	60	30	17	17	200	65	320	80	180	190	150	220	300	150	284	314	100	120	120
QGB 160	M33×2	M16	M27×2	60	30	17	17	243	65	320	80	215	190	150	220	300	150	284	314	100	120	120
QGA 200	M36	M20	M27×2	100	50	22	22	210	85	340	88	185	230	180	270	370	180	390	430	125	160	160
QGB 200	M36	M20	M27×2	100	50	22	22	248	85	340	88	223	230	180	270	370	180	390	430	125	160	160
QGAI250	M42×2	M24	M33×2	100	40	26	26	232	100	350	66	289	280	230	320	400	165	460	510	160	190	165
QGBI250	M42×2	M24	M33×2	100	40	26	26	232	100	350	66	289	280	230	320	400	165	460	510	160	190	165
QGAI320	M48×2	M30	M33×2	90	50	33	33	254	130	390	62	326	350	290	400	500	200	590	660	220	230	200
QGBI320	M48×2	M30	M33×2	90	50	33	33	254	130	390	62	326	350	290	400	500	200	590	660	220	230	200
QGA 400	M56×4	M36	M42×2	105	90		39	314		440	120	304	430	350	500	640						
QGB 400	M56×4	M36	M42×2	105	90		39	314		440	120	304	430	350	500	640						



3、带连接附件气缸

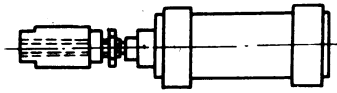

带管连接件 (L₁型)

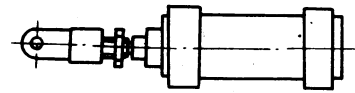

带杆连接件 (L₂型)

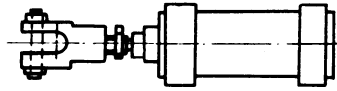

带叉连接件 (L₃型)

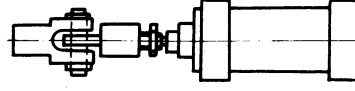

带杆叉组合连接件 (L₄型)

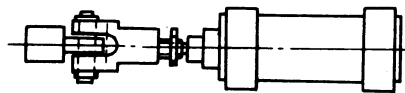

带叉杆组合连接件 (L₅型)

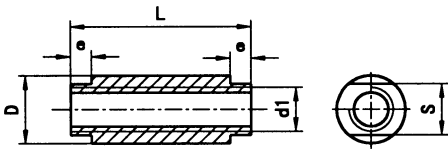

管连接件

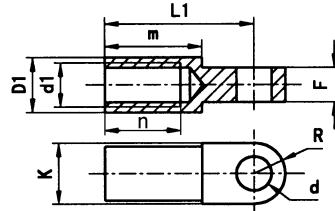

杆连接件

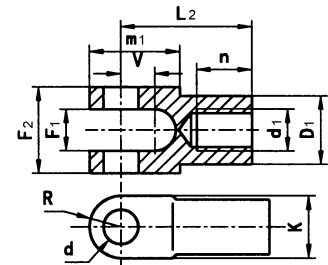

叉连接件

单位: mm

配用气缸型号	D	D ₁	F	F ₁	F ₂	d	d ₁	L	L ₁	L ₂	e	m	m ₁	n	S	K	R	V
QGA32 QGB 32	20	20	10	10	20	10	M10	60	40	35		22		15	17	20	10	13
QGA40 QGB 40	22	20	12	14	32	11	M12×1.25	80	55	55	7	30	35	20	19	24	12	14
QGA50 QGB 50																		
QGA63 QGB 63	28	30	16	18	42	13	M16×1.5	100	70	70	8	40	43	30	24	28	14	16
QGA80 QGB 80																		
QGA100 QGB 100	31	30	16	18	42	13	M20×1.5	100	70	70	9	40	43	30	27	28	14	16
QGA125 QGB 125	40	40	20	20	46	18	M27×2	120	80	80	10	50	54	36	32	39	19	21
QGA160 QGB 160	47	45	20	22	50	25	M33×2	120	100	100	11	60	68	40	41	50	25	27
QGA200 QGB200	70	70	36	36	70	35	M36	140	125	110	16	68	/	50	67	70	35	40
QGA1250 QGB1250	80	80	40	40	80	40	M42×2	150	135	135	16	70	/	70	77	80	40	45
QGA1320 QGB1320		85	55	55	102	55	M48×2		135	135	70	80	136	60		102	51	60
QGA400 QGB400		90		60	112	60	M56×4			150			160	70		120	60	65

